

BEFORE YOU BEGIN

Please read all the instructions before assembly.

Think about where your Sukkah will be placed. It needs to stand on fairly level ground. Please keep in mind on which side you want the door to be. Unless you ordered a special Sukkah the door will be on the right of a longer side of the Sukkah.

Unpack your Sukkah from the box and open all the packages. Take the time to familiarize yourself with all the parts. Please check the parts list on back page to make sure you are not missing anything.

If you think something is missing, please call our customer service department at **1-800-227-SUKA**

Assembling your Snap Sukkah System:

When assembling the frame of your Snap-Sukkah, we recommend that steps 1-3 be completed without leaving the frame partially standing for an extended amount of time. Failure to do so might cause damage to some of the pieces.

WHEN YOU FINISH

When using mat or bamboo Schach, (not included,) lay it perpendicular to the wooden supports. You may need extra supports to hold the weight of the bamboo.

Do not hang any decorations from mats. They are not designed to hold any weight. Decorations can be hung from the wooden supports or from bamboo rod-type Schach.

NOTE: If your Sukkah is placed in a large open area or is subject to strong winds, secure it using bungee cords (or other types of fastening material i.e. string) and tightening it to a secure object. This will help prevent it from shifting or blowing over.

**IN THE EVENT OF WIND, PLEASE REMOVE NYLON,
TO REDUCE THE RISK OF DAMAGE TO SUKKAH**

PART LIST

OPEN ALL PACKAGES BEFORE COUNTING

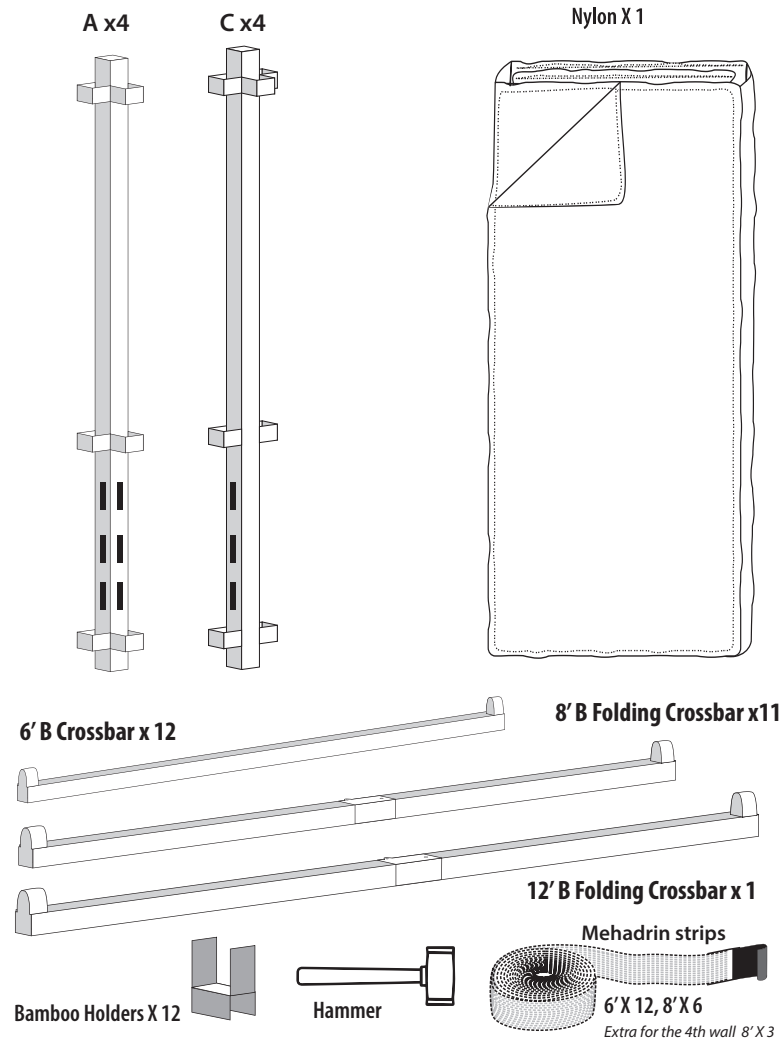

THE SUKKAH CENTER
3720 14th Avenue • Brooklyn, NY 11218
718-436-6333 • www.sukkah.com

© 2004 Sukkah Center • Brooklyn NY 11218



SNAP SUKKAH

12' x 16'

Actual size
143" x 191.5"

ASSEMBLY INSTRUCTIONS

**Your sukkah has
been designed for
E-Z installation**

Thank you for purchasing our Snap Sukkah System.
We hope you will enjoy many years of pleasant & enjoyable holidays with your sukkah. Your feedback is important to us. Please call us at

1-800-227-SUKA
www.sukkah.com